



TERAFEST®

PRÉMIOVÉ PRODUKTY

T E R A S Y
P L O T Y | O B K L A D Y



WWW.WOODPLASTIC.CZ

TERASOVÉ DOSKY



FOREST



PREMIUM ↗ ↘ 137 x 22 mm ← s → 4 m ← A → 2-6 m  3,3 kg / bm
 MAX ↙ ↚ 195 x 22 mm ← s → 4 m ← A → 2-4 m  4,6 kg / bm



FOREST PLUS *

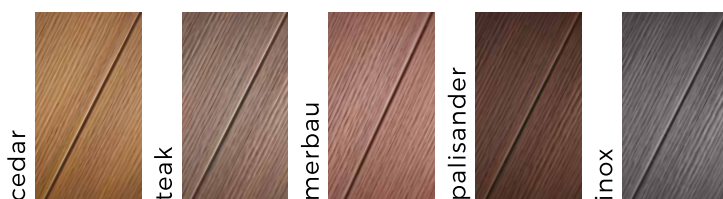



PREMIUM ↗ ↘ 137 x 22 mm ← s → 4 m ← A → 2-6 m  3,3 kg / bm

* PLUS - varianta se žiháním

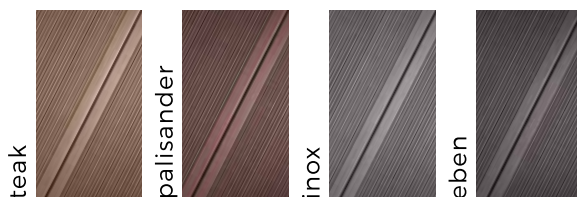

STAR



PREMIUM ↗ ↘ 137 x 23 mm ← s → 4 m  3,4 kg / bm



STYLE PLUS *





PREMIUM ↗ ↘ 137 x 23 mm ← s → 4 m  3,5 kg / bm

* PLUS - varianta se žiháním



RUSTIC



TOP ↗ ↘ 140 x 22 mm ← s → 4 m ← A → 2-6 m  3,3 kg / bm
 MAX ↙ ↚ 195 x 22 mm ← s → 4 m ← A → 2-4 m  4,6 kg / bm

PLOTY / OBKLADY / LIŠTY



PLOTOVKY 120 FOREST PLUS

PLOTOVKA 120

	cedar	teak	merbau	palisander	inox
↗ ↘	↗ ↘	↗ ↘	↗ ↘	↗ ↘	↗ ↘
↙ ↘	↙ ↘	↙ ↘	↙ ↘	↙ ↘	↙ ↘
	120 x 11 mm	← s →	3,6 m		1,7 kg / bm



OBKLADY FOREST ECO

ECO

	teak	merbau	palisander	wenge	inox
↗ ↘	↗ ↘	↗ ↘	↗ ↘	↗ ↘	↗ ↘
↙ ↘	↙ ↘	↙ ↘	↙ ↘	↙ ↘	↙ ↘
	150 x 14 mm	← s →	3,1 m		2,1 kg / bm

LIŠTY

HLADKÁ/ FOREST

cedar	teak	merbau	palisander	wenge	inox	eben
↗ ↘	↗ ↘	↗ ↘	↗ ↘	↗ ↘	↗ ↘	↗ ↘
↙ ↘	↙ ↘	↙ ↘	↙ ↘	↙ ↘	↙ ↘	↙ ↘
	70 x 16 mm	← s →	2 m		1,4 kg / bm	
	90 x 16 mm	← s →	2 m		1,7 kg / bm	

FOREST/ RUSTIC

NOVINKA

cedar	teak	palisander	wenge	inox	eben
↗ ↘	↗ ↘	↗ ↘	↗ ↘	↗ ↘	↗ ↘
↙ ↘	↙ ↘	↙ ↘	↙ ↘	↙ ↘	↙ ↘
	120 x 11 mm	← s →	3 m		1,7 kg / bm
	150 x 19 mm	← s →	4 m		3,4 kg / bm



PROFILY / PRÍSLUŠENSTVO

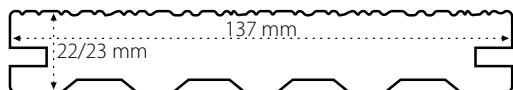

PREMIUM 

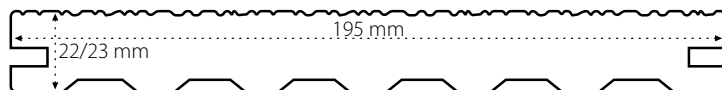

MAX 

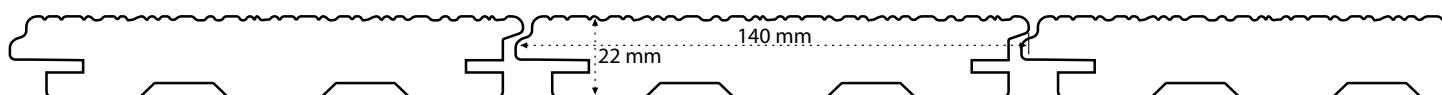

TOP 

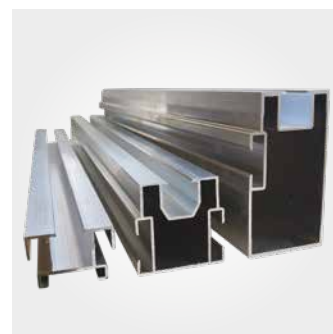
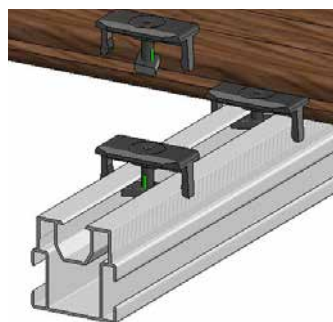

KLIPY, VRUTY, NOSIČE

Pre ľahké prichytenie dosiek k nosičom využite nere-zové klipy a vruty. Na výber sú hliníkové SMART alebo WPC nosiče.

Veľký nosič: 50 x 50 x 3000/4000 mm, 2,3 kg/bm

Malý nosič: 50 x 30 x 3000/4000 mm, 1,4 kg/bm

SMART – KOTVIACI HLINÍKOVÝ SYSTÉM

Systém obsahuje všetko potrebné pre rýchlu montáž terasy: nosiče, klipy a ďalší spojovací materiál.

Nosič 23: 23 x 35 x 4000 mm, 0,39 kg/bm

Nosič 40: 40 x 42 x 4000 mm, 0,67 kg/bm

Nosič 75: 75 x 40 x 4000 mm, 1,10 kg/bm

VYZRIEVANIE FARIEB



PO INŠTALÁCII

PO 1 MESIACI

PO 25 ROKOCH

INFORMÁCIE O MATERIÁLI

Materiál WoodPlastic® kombinuje v správnom pomere drevo (60%) a vysoko kvalitný, zdravotne nezávadný polymér HDPE (40%). Materiál je odolný voči poveternostným vplyvom, chlórovanej aj slanej vode a vďaka vysokej UV odolnosti je stálofarebný.



VYROBENÉ V ČR
Produkty WoodPlastic®
vyrábame v Českej republike
na základe americkej licencie
Strandex.



ZÁRUKA AŽ 25 ROKOV
Svojim produktom veríme, preto
poskytujeme záruku v dĺžke až
25 rokov. Životnosť terás však
laboratórne testy odhadujú na oveľa
dlhšiu dobu.



**BEZPEČNOSŤ
– BEZ TRIESOK**
Terasy WoodPlastic® majú
protišmykový povrch a na rozdiel
od dreva nikdy netvorí triesky.



**JEDNODUCHÁ ÚDRŽBA
– ŽIADNE NATIERANIE**
Terasy WoodPlastic® sa
nenatierajú, neolejújú ani inak
povrchovo neošetrujú.



7 DŮVODOV PREČO ZVOLIŤ DOSKY TERA FEST

MINIMÁLNA POTREBA ÚDRŽBY ŠETRÍ ČAS I PENIAZE. TERASY NIE JE POTREBNÉ NATIERAŤ, OLEJOVAŤ ANI IMPREGNOVAŤ.

ČESKÝ PRODUKT VYRÁBANÝ PODĽA AMERICKEJ LICENCIE. OVERENÝ MATERIÁL, NA TRHU DLHŠIE AKO 30 ROKOV.

EKOLOGICKÝ, 100% RECYKLOVATEĽNÝ A ZDRAVOTNE NEZÁVADNÝ VÝROBOK S PEFC CERTIFIKÁCIOU.

DOSKY MAJÚ PLNÝ PROFIL, SÚ ZAFARBENÉ A STÁLOFARBENÉ. ICH KVALITA SA ČASOM NEMENÍ.

BEZPEČNOSŤ ZAIŠŤUJE PROTIŠMYKOVÝ POVRCH BEZ TRIESOK A ŠTEPOV A SKRYTÉ KOTVENIE.

VÝROBKY ODOLÁVAJÚ DAŽĎU, SNEHU, MRAZU AJ UV ŽIARENÍU. MATERIÁL JE ODOLNÝ VOČI BAZÉNOVEJ CHÉMII I SLANEJ VODE.

PONUKA ZAHŔŇA ŠIROKÉ SPEKTRUM FAREBNÝCH ODTIEŇOV, POVRCHY SÚ ATRAKTÍVNE A PRÍJEMNÉ NA DOTYK.

WPC - WOODPLASTIC a.s.

BUKOVANY 181 | 257 41 TÝNEC NAD SÁZAVOU | ČESKÁ REPUBLIKA
+420 321 001 523 | WPC@WOODPLASTIC.CZ | WWW.WOODPLASTIC.CZ